

带快换接头的速度控制阀

弯头型 / 万向型

AS 系列



小型·轻量 优良的流量特性

高度小、能紧凑设计。但有效截面积不比老款产品小。

管子安装方向在 360°内可自由设定

对万向型。

适合管子尺寸 追加了Ø2

- 米制尺寸(释放套为白色)
ø2, ø3.2, ø4, ø6, ø8, ø10, ø12
- 英制尺寸(释放套为黄色)
ø1/8", ø5/32", ø3/16", ø1/4",
ø5/16", ø3/8", ø1/2"

最高使用压力 可1MPa

适合管子材质

尼龙、软尼龙、聚氨酯。

针阀有限拔机构

可选项 六角锁母镀镍规格

型号

弯头型	万向型	接管口径	适合管子外径																
			米制尺寸						英制尺寸										
			2	3.2	4	6	8	10	12	1/8"	5/32"	3/16"	1/4"	5/16"	3/8"	1/2"			
AS12□1F-M3	AS13□1F-M3	M3x0.5	◎ ^{注3)}	◎	◎								◎	◎	◎				
AS12□1F-M5	AS13□1F-M5	M5x0.8	◎ ^{注3)}	◎	◎								◎	◎	◎	◎			
AS12□1F-U10/32	AS13□1F-U10/32	10-32UNF		◎	◎								◎	◎	◎				
AS22□1F-01	AS23□1F-01	R1/8		◎	◎			◎ ^{注2)}					◎	◎	◎				
AS22□1F-02	AS23□1F-02	R1/4			◎	◎	◎	◎					◎	◎	◎	◎	◎	◎	◎
AS32□1F-02	AS33□1F-02	R1/4				◎	◎	◎	◎						◎	◎	◎	◎	◎
AS32□1F-03	AS33□1F-03	R3/8					◎	◎	◎	◎					◎	◎	◎	◎	◎
AS42□1F-04	AS43□1F-04	R1/2													◎	◎	◎	◎	◎

- 注1) AS12□1F-M5-02的适合缸径为2.5, 4, 6。
 注2) 仅弯头型。
 注3) 排气节流式和进气节流式是通过锁母进行外观识别。
 排气节流式为无电解镀锌，进气节流式为黑色铬酸钝。
 注4) ◎印为标准品时是无电解镀锌规格(N规格)。

规格

使用流体	空气
保证耐压力	1.5MPa(注1)1.05MPa)
最高使用压力	1MPa(注1)0.7MPa)
最低使用压力	0.1MPa
环境及使用流体温度	-5~60°C(未冻结时)
注2) 适合管子材质	尼龙、软尼龙、注3)聚氨酯
可选项	注4)带密封剂、六角锁母、注5)无电解镀锌规格

- 注1) AS12□1F-M3-02, AS12□1F-M5-02型の場合。
 注2) 注意软尼龙、聚氨酯的最高使用压力。
 (详见P.411, 412.)
 注3) AS12□1F-M3-02, AS12□1F-M5-02の場合、仅为聚氨酯。
 注4) 连接口径M3, M5, 10-32UNFの場合没有带密封剂的形式。
 注5) 黄铜零件全为无电解镀锌。

流量及声速流导

型号	AS12□1F-M3 AS13□1F-M3 AS12□1F-M5-02	AS12□1F-M5 AS13□1F-M5	AS22□1F-01 AS23□1F-01	AS22□1F-02 AS23□1F-02	AS32□1F AS33□1F	AS42□1F AS43□1F							
	米制	ø2, ø3.2, ø4	ø3.2, ø4, ø6	ø3.2, ø4, ø6, ø8, ø10	ø4, ø6, ø8, ø10	ø6, ø8, ø10, ø12, ø10, ø12							
管子外径	英制	ø1/8", ø5/32"	ø1/8", ø3/16", ø5/32"	ø1/8", ø3/16", ø1/4", ø5/16"	ø5/32", ø3/16", ø1/4", ø5/16", ø3/8"	ø1/4", ø5/16", ø3/8", ø3/8", ø1/2"							
控制流动	注1)流量L/min(ANR)	20	100	180	230	260	390	460	660	790	920	1580	1710
自由流动	声速流导 dm ³ /sec(bar)	0.06	0.28	0.5	0.64	0.72	1.1	1.3	1.8	2.2	2.6	4.4	4.8
临界	控制流动	0.2	0.2	0.25		0.3		0.3		0.25		0.25	
压力比	自由流动	0.4	0.4	0.2		0.3		0.3		0.2		0.3	

- 注1) 流量是压力0.5MPa、温度20°C时的值。
 注2) U10/32与M5相同。



JIS符号

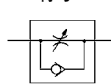

阀体上表示的流动方向记号

	排气节流式	进气节流式
记号		
JIS符号		

注意

使用前必读。
 安全上的注意请参考前附56、驱动控制元件 / 共同注意事项由P.468~471确认。

Order Made 订制规格 (详见P.490.)

型号表示方法

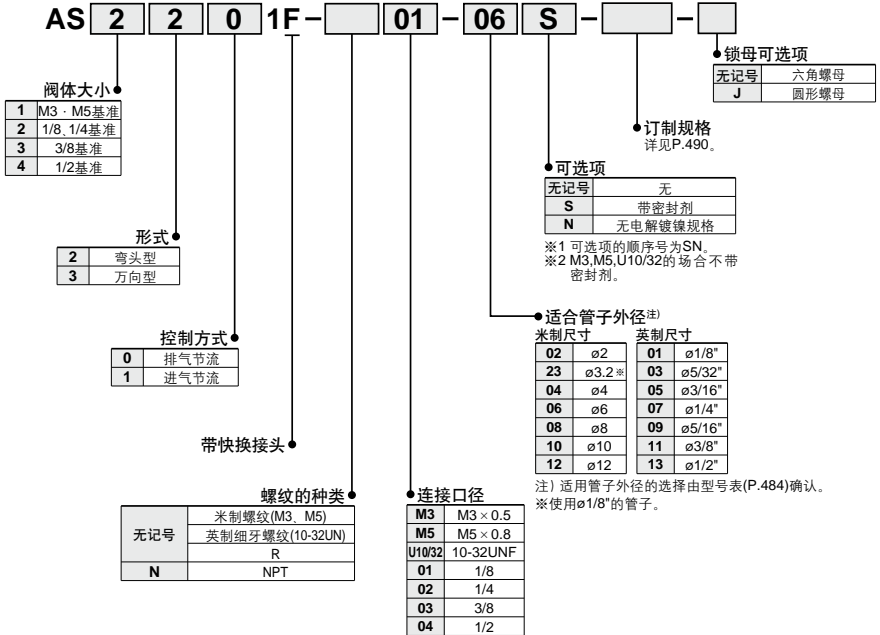

- AS
- TMH
- ASD
- AS
- AS-FE KE
- AS-FG
- AS-FP
- AS-FM
- AS-D AS-T
- ASP
- ASN
- AQ
- ASV
- AK
- VCHC
- ASS
- ASR ASQ

针阀/流量特性

注) 流量特性为代表值。

AS1201F-M3、AS1211F-M3
AS1301F-M3、AS1311F-M3
AS1201F-M5-02、AS1211F-M5-02

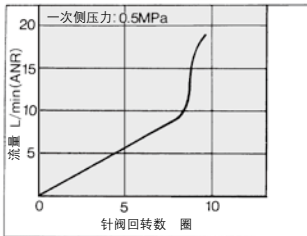

AS1201F-M5、AS1211F-M5
AS1301F-M5、AS1311F-M5

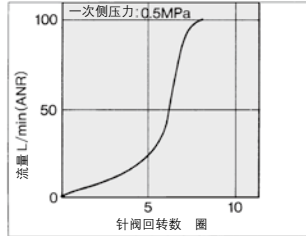

AS2201F-01、AS2211F-01
AS2301F-01、AS2311F-01

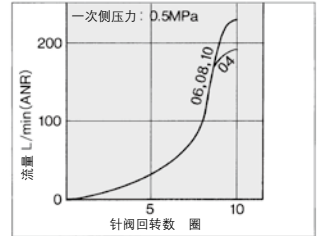

AS2201F-02、AS2211F-02
AS2301F-02、AS2311F-02

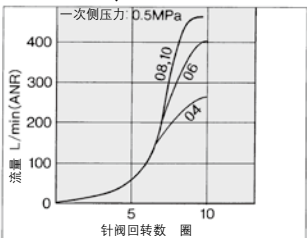

AS3201F、AS3211F
AS3301F、AS3311F

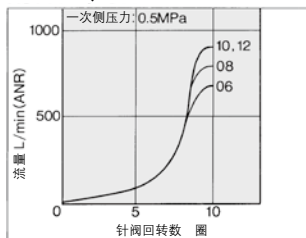

AS4201F、AS4211F
AS4301F、AS4311F

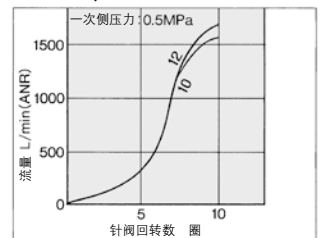

AS 系列

结构图

弯头型
排气节流式

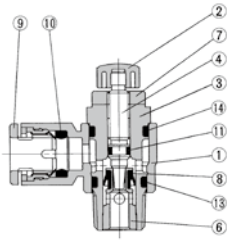

M3型
M5型
U10/32型

φ2配管型

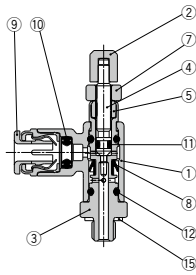
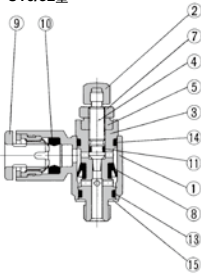

进气节流式

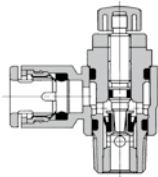

M3型
M5型
U10/32型

φ2配管型

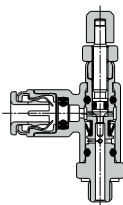
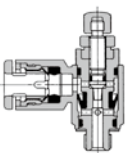

万向型
排气节流式

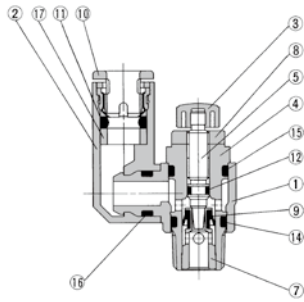

M3型
M5型
U10/32型

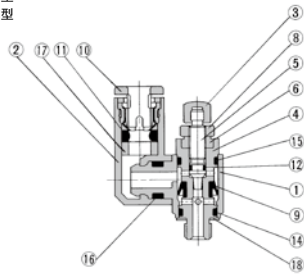

进气节流式

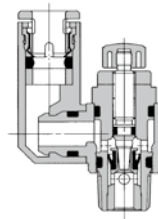

M3型
M5型
U10/32型

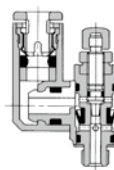

结构图

弯头型

排气节流式 AS3201F-02

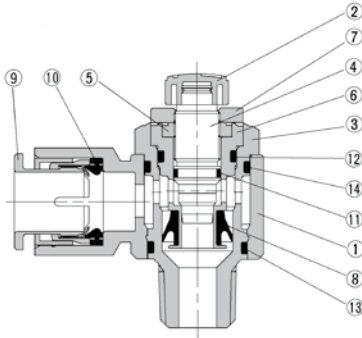

进气节流式 AS3211F-02

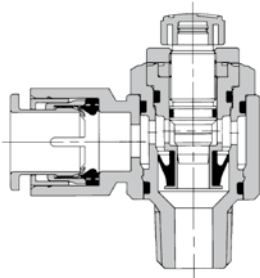

万向型

排气节流式 AS3301F-02

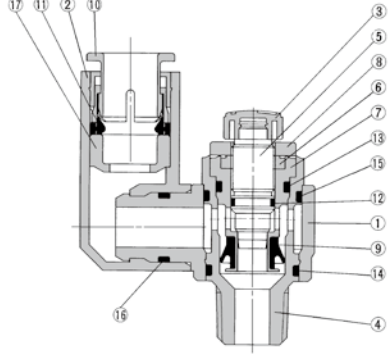

进气节流式 AS3311F-02

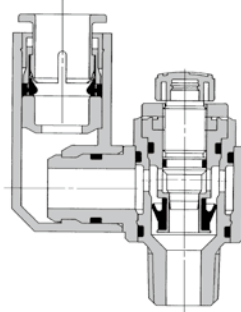

构成零件

序号	名称	材质	备注
1	阀体A	PBT	
2	手轮	PBT注1)	
3	阀体B	黄铜注2)	无电镀锌
4	针阀	黄铜	无电镀锌
5	针阀导座	黄铜	无电镀锌
6	护环	黄铜	注3)
7	锁母	钢注4)	排气节流 铬酸锌注5) 进气节流 黑色铬酸锌
8	U形密封圈	HNBR	
9	释放套	-	
10	密封圈	NBR	
11	O形圈	NBR	
12	O形圈	NBR	
13	O形圈	NBR	
14	O形圈	NBR	
15	密封垫	NBR-不锈钢	

注1) AS12□1F-M3、AS12□1F-M5-02的黄铜上为无电镀锌。

注2) AS12□1F-M3为不锈钢。

注3) AS22□1F、AS32□1F为无电镀锌。

※适合管子外径3/8"除外。

注4) 锁紧螺母可选项-J(圆形)的材质为黄铜。仅AS22□1F是钢。

注5) 锁紧螺母可选项-J(圆形)的表面处理时无电镀锌。

构成零件

序号	名称	材质	备注
1	阀体A	PBT	
2	弯头体	PBT	
3	手轮	PBT注1)	
4	阀体B	黄铜注2)	无电镀锌
5	针阀	黄铜	无电镀锌
6	针阀导座	黄铜	无电镀锌
7	护环	黄铜	注3)
8	锁母	钢注4)	排气节流 铬酸锌注5) 进气节流 黑色铬酸锌
9	U形密封圈	HNBR	
10	释放套	-	
11	密封圈	NBR	
12	O形圈	NBR	
13	O形圈	NBR	
14	O形圈	NBR	
15	O形圈	NBR	
16	O形圈	NBR	
17	衬套	-	
18	密封垫	NBR-不锈钢	

注1) AS13□1F-M3的黄铜上为无电镀锌。

注2) AS13□1F-M3为不锈钢。

注3) AS23□1F、AS33□1F为无电镀锌。

※适合管子外径3/8"除外。

注4) 锁紧螺母可选项-J(圆形)的材质为黄铜。仅AS23□1F是钢。

注5) 锁紧螺母可选项-J(圆形)的表面处理时无电镀锌。

AS

TMH

ASD

AS

AS-FE

KE

AS-FG

AS-FP

AS-FM

AS-D

AS-T

ASP

ASN

AQ

ASV

AK

VCHC

ASS

ASR

ASQ

AS 系列



弯头型

M3型的场合
M5型的场合
U10/32型的场合

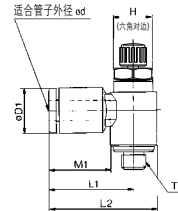
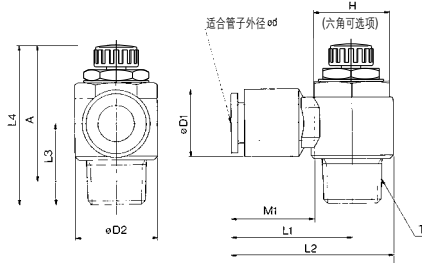

$\phi 2$ 配管的场合
AS12□1F-M3-02的场合
AS12□1F-M5-02的场合

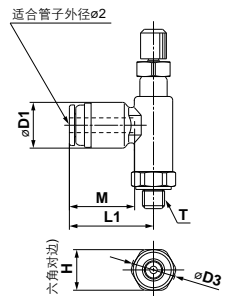
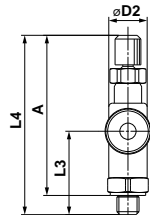

米制尺寸

型号	配合管径 d	T	H 注1)	D1	D2	D3	L1	L2	L3	注3) L4		注2) A		M1	质量 g
										MAX.	MIN.	MAX.	MIN.		
AS12□1F-M3-02	2	M3 × 0.5	5.5	6	5.2	6	11.4	—	11	26.8	24.3	24.3	21.8	8.8	2.4
AS12□1F-M5-02	3.2	M5 × 0.8	7	8.4	7.5	—	—	—	10.5	27.3	24.8	—	—	—	3
AS12□1F-M3-23	3.2	M3 × 0.5	5.5	8.4	7.2	—	16.1	19.7	10	26.6	24.1	24	21.5	12.7	4
AS12□1F-M3-04	4	M3 × 0.5	6.5	9.3	—	—	—	—	12.3	—	—	—	—	—	—
AS12□1F-M5-23	3.2	M5 × 0.8	—	8.4	—	—	17.3	22.1	—	—	—	—	—	—	—
AS12□1F-U1032-23	3.2	10-32UNF	—	8.4	—	—	17.3	22.1	—	—	—	—	—	—	—
AS12□1F-U1032-03	3.2	10-32UNF	—	8.4	—	—	17.3	22.1	—	—	—	—	—	—	—
AS12□1F-M5-04	4	M5 × 0.8	8	9.3	9.6	—	17.3	22.1	—	28.6	25.8	25	22.2	—	7
AS12□1F-U1032-04	4	10-32UNF	—	9.3	—	—	17.3	22.1	—	—	—	—	—	—	—
AS12□1F-M5-06	6	M5 × 0.8	—	11.6	—	—	18.1	22.9	11.7	—	—	—	—	13.5	—
AS12□1F-U1032-06	6	10-32UNF	—	11.6	—	—	18.1	22.9	11.7	—	—	—	—	—	—
AS22□1F-01-23	3.2	—	—	9.3	—	—	20.4	27.5	—	—	—	—	—	12.7	16
AS22□1F-01-04	4	—	—	9.3	—	—	20.4	27.5	—	—	—	—	—	17	—
AS22□1F-01-06	6	1/8	12	11.6	14.2	—	20.4	27.5	13.4	35.2	30.2	32.1	27.1	13.5	—
AS22□1F-01-08	8	—	(注2)	15.2	—	—	25.3	32.4	—	—	—	—	—	18.5	19
AS22□1F-01-10	10	—	—	18.5	—	—	32.1	39.2	14.1	—	—	—	—	21	21
AS22□1F-02-04	4	—	—	10.4	—	—	25.2	34.4	—	—	—	—	—	16	32
AS22□1F-02-06	6	—	—	12.8	—	—	28.2	34.4	17.7	—	—	—	—	17	—
AS22□1F-02-08	8	—	—	15.2	18.5	—	27.2	36.4	—	39.9	34.9	34.4	29.4	18.5	34
AS22□1F-02-10	10	—	—	18.5	—	—	35.3	44.5	18.3	—	—	—	—	21	36
AS32□1F-02-06	6	—	1/4	12.8	—	—	27.8	39.3	—	—	—	—	—	17	60
AS32□1F-02-08	8	—	—	15.2	—	—	29.5	41	—	21.3	48.3	43.3	42.8	18.5	63
AS32□1F-02-10	10	—	—	18.5	—	—	31.8	43.3	—	—	—	—	—	21	67
AS32□1F-03-06	6	—	—	12.8	—	—	27.8	39.3	—	—	—	—	—	17	55
AS32□1F-03-08	8	—	—	15.2	—	—	29.5	41	—	—	—	—	—	18.5	57
AS32□1F-03-10	10	—	—	18.5	—	—	31.8	43.3	—	19.8	45.4	40.4	40.2	35.2	21
AS32□1F-03-12	12	—	—	20.9	—	—	32.8	44.3	—	—	—	—	—	22	61
AS42□1F-04-10	10	—	—	18.5	—	—	33.6	47.9	—	—	—	—	—	21	100
AS42□1F-04-12	12	1/2	24 (注3)	21.7	28.6	—	35.2	49.5	24.5	56.7	49.2	49.6	42.1	21	100
AS42□1F-04-12	12	—	—	21.7	—	—	35.2	49.5	—	—	—	—	—	22	101

英制尺寸

型号	配合管径 d	T	H 注1)	D1	D2	D3	L1	L2	L3	注3) L4		注2) A		M1	质量 g
										MAX.	MIN.	MAX.	MIN.		
AS12□1F-M3-01	1/8"	M3 × 0.5	5.5	8.4	7.2	16.1	19.7	10.5	10	26.6	24.1	24	21.5	12.7	4
AS12□1F-M3-03	5/32"	M3 × 0.5	—	8.4	—	—	17.3	22.1	—	—	—	—	—	—	—
AS12□1F-M5-01	1/8"	M5 × 0.8	—	8.4	—	—	17.3	22.1	—	12.3	28.6	25.8	25	22.2	12.7
AS12□1F-M5-03	5/32"	M5 × 0.8	—	8.4	—	—	17.3	22.1	—	—	—	—	—	—	—
AS12□1F-U1032-03	5/32"	10-32UNF	—	8.4	—	—	17.3	22.1	—	—	—	—	—	—	—
AS12□1F-M5-05	3/16"	M5 × 0.8	—	11.4	—	—	21.3	26.1	—	—	—	—	—	16.5	7
AS12□1F-U1032-05	3/16"	10-32UNF	—	11.4	—	—	21.3	26.1	—	—	—	—	—	—	—
AS12□1F-M5-07	1/4"	M5 × 0.8	—	12	—	—	19.8	23.1	11.7	28.6	25.8	25	22.2	—	—
AS12□1F-U1032-07	1/4"	10-32UNF	—	12	—	—	19.8	23.1	—	—	—	—	—	13.5	7
AS22□1F-01-01	1/8"	—	—	9.3	—	—	20.4	27.5	—	—	—	—	—	12.7	16
AS22□1F-01-03	5/32"	—	—	9.3	—	—	20.4	27.5	—	—	—	—	—	17	—
AS22□1F-01-05	3/16"	1/8	12 (注2)	11.4	14.2	—	20.4	27.5	13.4	35.2	30.2	32.1	27.1	16.5	17
AS22□1F-01-07	1/4"	—	—	13.2	—	—	23.9	31	—	—	—	—	—	17	19
AS22□1F-01-09	5/16"	—	—	15.2	—	—	25.3	32.4	14.1	—	—	—	—	18.5	21
AS22□1F-02-03	5/32"	—	—	10.4	—	—	25.2	34.4	—	—	—	—	—	16	32
AS22□1F-02-05	3/16"	—	—	11.4	—	—	24.9	34.2	17.7	—	—	—	—	16.5	—
AS22□1F-02-07	1/4"	—	—	13.2	18.5	—	25.2	34.5	—	39.9	34.9	34.4	29.4	17	34
AS22□1F-02-09	5/16"	—	—	15.2	—	—	27.2	36.4	18.2	—	—	—	—	18.5	36
AS22□1F-02-11	3/8"	1/4	—	18.5	—	—	35.3	44.5	18.8	—	—	—	—	21	36
AS22□1F-02-17	1/4"	—	—	13.2	—	—	27.8	39.3	—	—	—	—	—	17	60
AS32□1F-02-09	5/16"	—	—	15.2	—	—	29.5	41	21.3	48.3	43.3	42.8	37.8	18.5	63
AS32□1F-02-11	3/8"	—	—	17.9	—	—	31.8	43.3	—	—	—	—	—	21	67
AS32□1F-03-07	1/4"	—	—	13.2	—	—	27.8	39.3	—	—	—	—	—	17	55
AS32□1F-03-09	5/16"	3/8	—	15.2	—	—	29.5	41	19.8	45.4	40.4	40.2	35.2	18.5	57
AS32□1F-03-11	3/8"	—	—	17.9	—	—	31.8	43.3	—	—	—	—	—	21	59
AS42□1F-04-11	3/8"	—	—	17.9	—	—	33.6	47.9	—	—	—	—	—	21	100
AS42□1F-04-13	1/2"	1/2	24 (注3)	21.7	28.6	—	35.2	49.5	24.5	56.7	49.2	49.6	42.1	22	101

注1) ()内为NPT螺纹的尺寸
注2) 螺纹拧入后的参考尺寸
注3) 参考尺寸



万向型

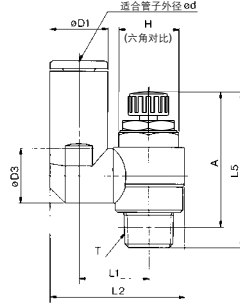
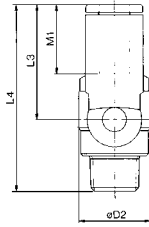

M3型的场合
M5型的场合
U10/32型的场合

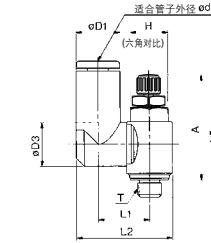
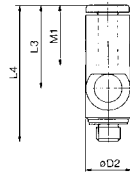

米制尺寸

型号	适合管子外径 d	T	H 注1)	D1	D2	D3	L1	L2	L3	L4	注3) L5		注2) A		M1	质量 g
											MAX.	MIN.	MAX.	MIN.		
AS13□1F-M3-23	3.2	M3x0.5	5.5	8.4	7.2	7.2	10.1	17.9	17.6	28.3	26.6	24.1	24	21.5	12.7	4
AS13□1F-M3-04	4	M5x0.8	9.3	9.3	7.2	10.1	18.3	17.9	28.6	26.6	24.1	24	21.5	12.7	5	
AS13□1F-M5-23	3.2	M5x0.8	8.4	8.4			19.8								12.7	7
AS13□1F-U10/32-23	10-32UNF		8	9.3	9.6	9.3	10.8	20.3			28.6	25.8	25	22.2		7
AS13□1F-U10/32-04	10-32UNF		8	9.3	9.6	9.3	10.8	20.3			28.6	25.8	25	22.2		7
AS13□1F-M5-06	M5x0.8		11.6				21.4	20.6	31.8						13.5	8
AS13□1F-U10/32-06	10-32UNF		11.6				21.4	20.6	31.8						13.5	8
AS23□1F-01-23	3.2		12	8.4			9.3	13.1	24.4		35.2	30.2	32.1	27.1	12.7	17
AS23□1F-01-04	4		12	9.3			10.9	14	24.9		35.2	30.2	32.1	27.1	13.5	18
AS23□1F-01-06	6	1/8	(12.7)	11.6			12.9	16.2	29.9		35.2	30.2	32.1	27.1	18.5	21
AS23□1F-01-08	8			15.2			12.9	16.2	30.9		35.2	30.2	32.1	27.1	18.5	21
AS23□1F-02-04	4		17	10.4			12.9	16.2	30.6		35.2	30.2	32.1	27.1	16	32
AS23□1F-02-06	6		(17.5)	12.8			12.9	18.3	35.2		35.2	30.2	32.1	27.1	17	33
AS23□1F-02-08	8			15.2			12.9	18.3	35.2		35.2	30.2	32.1	27.1	18.5	36
AS23□1F-02-10	10			18.5			12.9	20.2	38.7		35.2	30.2	32.1	27.1	21	40
AS23□1F-02-10	10		1/4	18.5			12.9	20.2	38.7		35.2	30.2	32.1	27.1	21	40
AS33□1F-02-06	6			12.8			12.9	20.6	38.5		48.3	43.3	42.8	37.8	16.5	63
AS33□1F-02-08	8			15.2			12.9	20.6	38.5		48.3	43.3	42.8	37.8	18.5	63
AS33□1F-02-10	10			18.5			12.9	23	43.7		48.3	43.3	42.8	37.8	21	67
AS33□1F-02-12	12			20.9			12.9	23	44.9		48.3	43.3	42.8	37.8	22	69
AS33□1F-03-06	6		19	12.8			12.9	20.6	38.5		45.4	40.4	40	35	17	56
AS33□1F-03-08	8			15.2			12.9	20.6	38.5		45.4	40.4	40	35	18.5	59
AS33□1F-03-10	10			18.5			12.9	23	43.7		45.4	40.4	40	35	21	63
AS33□1F-03-12	12			20.9			12.9	23	44.9		45.4	40.4	40	35	22	65
AS43□1F-04-10	10			18.5			16.2	25.8	49.4		56.7	49.2	49.6	42.1	21	104
AS43□1F-04-12	12	1/2	(23.8)	21.7			19.4	26.8	52		56.7	49.2	49.6	42.1	22	106

注1) ()内为NPT螺纹的尺寸。
注2) 螺纹拧入后的参考尺寸。
注3) 参考尺寸

英制尺寸

型号	适合管子外径 d	T	H 注1)	D1	D2	D3	L1	L2	L3	L4	注3) L5		注2) A		M1	质量 g
											MAX.	MIN.	MAX.	MIN.		
AS13□1F-M3-01	1/8"		5.5	8.4	7.2	7.2	10.1	17.9	17.6	28.3	26.6	24.1	24	21.5	12.7	4
AS13□1F-M3-03	1/8"	M3x0.5	9.3	9.3	7.2	10.1	18.3	17.9	28.6	26.6	24.1	24	21.5	12.7	5	
AS13□1F-M5-01	1/8"	M5x0.8	8.4	8.4			19.8								12.7	7
AS13□1F-U10/32-01	1/8"	10-32UNF	8	9.6	9.3	10.8	20.3				28.6	25.8	25	22.2	12.7	7
AS13□1F-U10/32-03	1/8"	10-32UNF	8	9.6	9.3	10.8	20.3				28.6	25.8	25	22.2	12.7	7
AS13□1F-M5-05	5/32"	M5x0.8	11.4				21.3	23.3	34.5						16.5	8
AS13□1F-M5-05	3/16"	M5x0.8	11.4				21.3	23.3	34.5						16.5	8
AS13□1F-U10/32-05	3/16"	10-32UNF	8	9.6	9.3	10.8	21.6	20.7	31.9		28.6	25.8	25	22.2	13.7	8
AS13□1F-U10/32-07	1/4"	10-32UNF	12				21.6	20.7	31.9						13.7	8
AS23□1F-01-01	1/8"		12	8.4			9.3	13.1	24.4		35.2	30.2	32.1	27.1	12.7	17
AS23□1F-01-03	3/32"		12	9.3			10.9	14	24.9		35.2	30.2	32.1	27.1	13.5	18
AS23□1F-01-04	1/8"		(12.7)	11.6			12.9	16.2	29.9		35.2	30.2	32.1	27.1	18.5	21
AS23□1F-01-07	1/4"			13.2			12.9	16.2	29.9		35.2	30.2	32.1	27.1	17	19
AS23□1F-01-09	5/16"			15.2			12.9	16.2	30.9		35.2	30.2	32.1	27.1	18.5	21
AS23□1F-02-03	5/32"			10.4			10.9	16.2	30.6		35.2	30.2	32.1	27.1	16	32
AS23□1F-02-05	3/16"			11.6			10.9	16.2	31.1		35.2	30.2	32.1	27.1	16	32
AS23□1F-02-05	3/16"		(17.5)	13.2			11.6	14.2	26.8		35.2	30.2	32.1	27.1	16.5	33
AS23□1F-02-07	1/4"			15.2			12.9	18.3	35.2		35.2	30.2	32.1	27.1	17	36
AS23□1F-02-09	5/16"			18.5			12.9	18.3	35.2		35.2	30.2	32.1	27.1	18.5	39
AS23□1F-02-11	3/8"			20.2			12.9	20.2	38.7		35.2	30.2	32.1	27.1	21	40
AS33□1F-02-07	1/4"			13.2			12.9	20.6	38.7		45.4	40.4	40	35	17	60
AS33□1F-02-09	5/16"			15.2			12.9	20.6	38.7		45.4	40.4	40	35	18.5	63
AS33□1F-02-11	3/8"			18.5			12.9	23	43.7		45.4	40.4	40	35	21	69
AS33□1F-03-07	1/4"			13.2			12.9	20.6	38.7		45.4	40.4	40	35	17	56
AS33□1F-03-07	1/4"			15.2			12.9	20.6	38.7		45.4	40.4	40	35	18.5	59
AS33□1F-03-11	3/8"			18.5			12.9	23	43.7		45.4	40.4	40	35	21	65
AS43□1F-04-11	3/8"		1/2	24			16.2	25.8	49.4		56.7	49.2	49.6	42.1	21	104
AS43□1F-04-13	1/2"		(23.8)	21.7			19.4	26.8	52		56.7	49.2	49.6	42.1	22	106

注1) ()内为NPT螺纹的尺寸。
注2) 螺纹拧入后的参考尺寸。
注3) 参考尺寸

AS 系列 订制规格

详细尺寸·规格及交货期由本公司确认。



1 润滑剂: 凡士林

X12

(例) AS2201F-01-04S-X12

2 无润滑脂(密封材料氟涂层) + 节流阀(无单向阀)

X21

(例) AS2201F-01-04S-X21

注1) 不是无发尘。
注2) 节流阀仅排气节流的型号。

3 节流阀(无单元阀)

X214

(例) AS2201F-01-04S-X214

注) 节流阀仅排气节流的型号。

4 固定节流(无针阀功能)

X250

型号表示方法

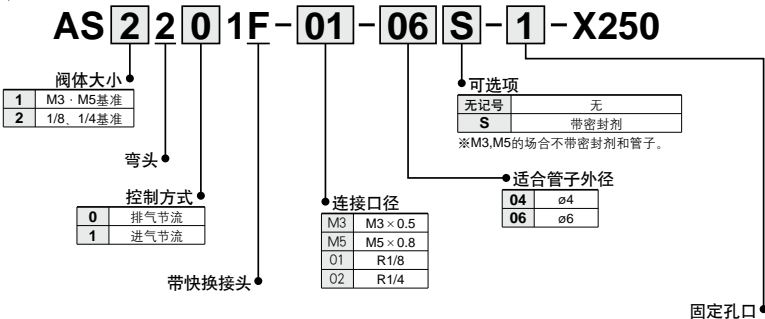

记号	固定孔口	适合型号			
		AS12□1F-M3-04	AS12□1F-M5-04 AS12□1F-M5-06	AS22□1F-01-04 AS22□1F-01-06	AS22□1F-02-06
1	φ0.1	○	○	○	○
2	φ0.2	○	○	○	○
3	φ0.3	○	○	○	○
4	φ0.4	○	○	○	○
5	φ0.5	○	○	○	○
6	φ0.6	○	○	○	○
7	φ0.7	○	○	○	○
8	φ0.8	○	○	○	○
9	φ0.9	○	○	○	○
10	φ1.0	○	○	○	○

每个气缸缸径的孔口与气缸速度的关系如下图所示。作为选定时的参考。图中的缸速为理论值。实际的速度与配管条件及气缸的滑动阻抗有关。作为大致参考。

